

PL and KCPL Retrofit Louvers



Aluminum Parabolic Louvers



Flange / Frame Options

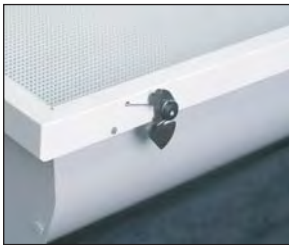

Box Flange for Door Replacement

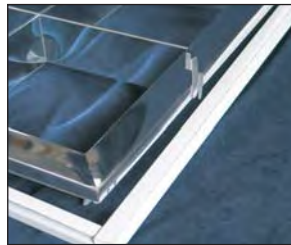

Flat Flange for existing Door Frame



Shallow Kwik Change

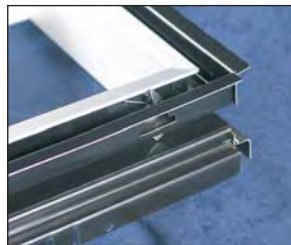

Deep Kwik Change

Material / Finish

- Baked White Enamel
- Semi-Specular Silver
- Specular Silver

Standard Cell Configurations

2' x 2' Panel

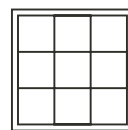

(3 x 3)
9 Cell

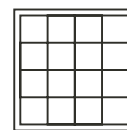

(4 x 4)
16 Cell

These and other special sizes and cellular patterns are available

2' x 4' Panel

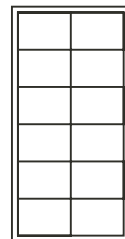

(2 x 6)
12 Cell

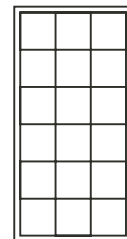

(3 x 6)
18 Cell

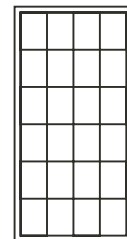

(4 x 6)
24 Cell

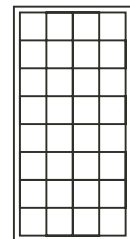

(4 x 8)
32 Cell

1' x 4' Panel

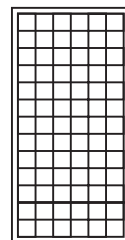

(6 x 13)
78 Cell

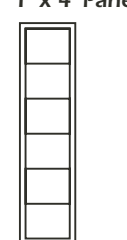

(1 x 6)
6 Cell

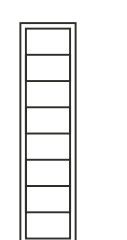

(1 x 8)
8 Cell

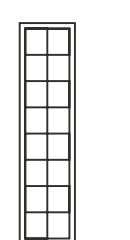

(2 x 8)
16 Cell

PL and KCPL Retrofit Louver

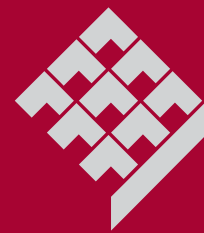

Lay-in Fixture Lighting Components

Lay-In Fixture Lighting Components

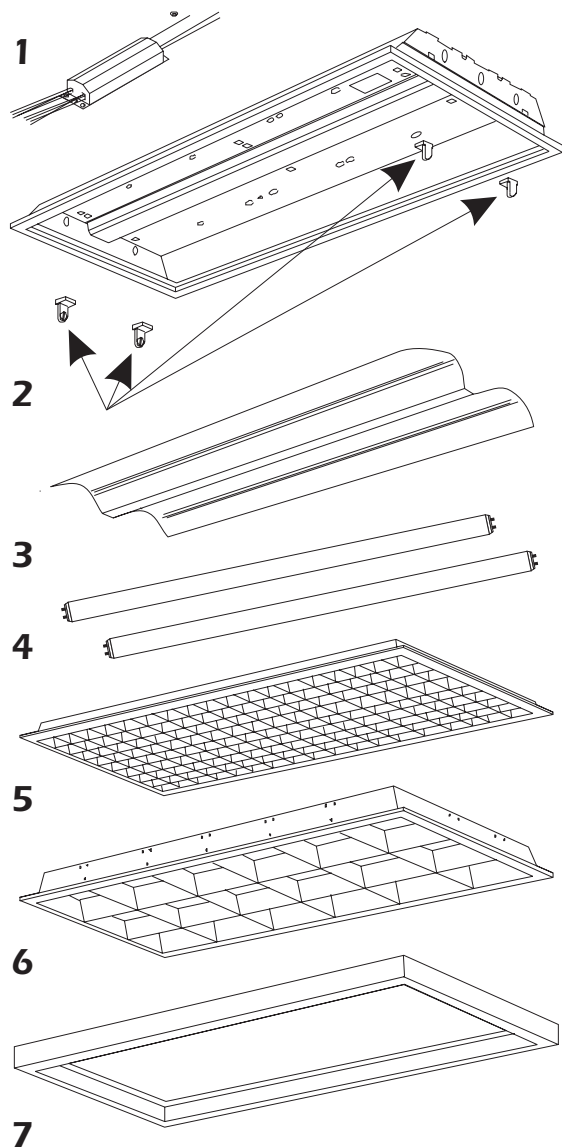

1. **Ballast** - High performance, solid state electronic ballast.
2. **Lampholders** - replaces broken or inoperative lampholders or for replacement when delamping.
3. **Reflector** - for 2, 3 or 4 lamp fixtures. Maintains or enhances the efficiency of a fixture when delamping or retaining lamps in an existing fixture.
4. **Lamps** - T5, T8 or T12 Fluorescent lamps
5. **PLLA Aluminum Parabolic Louver**
6. **PLNA Aluminum Parabolic Louver**
7. **Kwik-Change™ System** - allows changing a grid ceiling fixture from lens to contemporary parabolic louvers without replacing the fixtures.



A.L.P.
LIGHTING COMPONENTS, INC.
CORPORATE HQ: CHICAGO, IL U.S.A.

For Customer Support and Service Contact us at:
(800) 621-1348 • FAX: (800) 438-2500 • www.alplighting.com
© 2004 A.L.P. LIGHTING COMPONENTS, INC., PRINTED IN THE U.S.A., PLRL 0704