

## Snap-A-Wrap

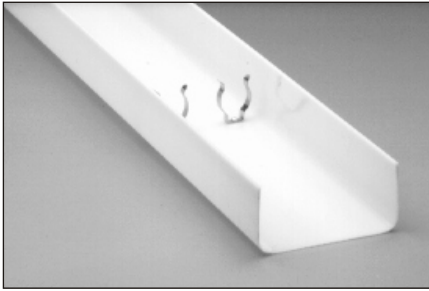

SAW 140 (48") or  
SAW 196 (96")  
Width — 3-1/2"  
Height — 2-1/4"  
Clip Placement — On center  
Clip Adjustment (ea.) — None

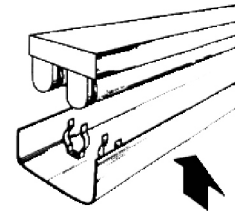
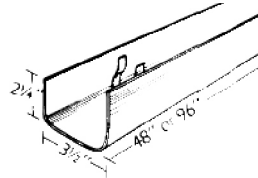

SAW 240 (48") or  
SAW 296 (96")  
Width — 5-1/2"  
Height — 2-3/4"  
Clip Placement — 2-3/4" on center  
Clip Adjustment (ea.) — 1/2"

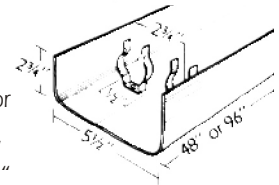

### END CAPS

- Available in clear or white acrylic
- Provides finished look on end row fixtures

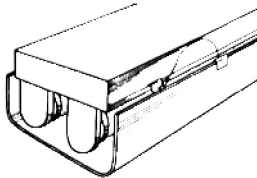
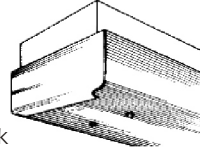

### SAFETY WIRE

For Added Safety

- Secures Strip Diffuser to fixture
- Easily clips onto fixture ballast cover
- Protects against failing lamps
- Holds strip-mate during relamping

### Description

A simple clip-on economical method of converting a bare lamp striplight to a fully enclosed wraparound fixture.

CATALOG NO.	DESCRIPTION	NO. LAMPS	OVERALL LENGTH
SAW 140CA	Clear Prismatic Acrylic	1	48"
SAW 140WA	White Prismatic Acrylic	1	48"
SAW 196CA	Clear Prismatic Acrylic	1	96"
SAW 196WA	White Prismatic Acrylic	1	96"
SAW 240CA	Clear Prismatic Acrylic	2	48"
SAW 240WA	White Prismatic Acrylic	2	48"
SAW 296CA	Clear Prismatic Acrylic	2	96"
SAW 296WA	White Prismatic Acrylic	2	96"
End Plates (Specify if Required)			
SAWE 1	1 Lite End Plate	1	—
SAWE 2	2 Lite End Plates	2	—
SAWEP 1CA	1 Lite End Plate, Clear	1	—
SAWEP 1WA	1 Lite End Plate, White	1	—
SAWEP 2CA	2 Lite End Plates, Clear	2	—
SAWEP 2WA	2 Lite End Plates, White	2	—
SAW SW	Safety Wire	—	—
SAW CLIP T8	T8 Lamp Clips	—	—
SAW CLIP T12	T12 Lamp Clips	—	—

## Standard Wraparounds

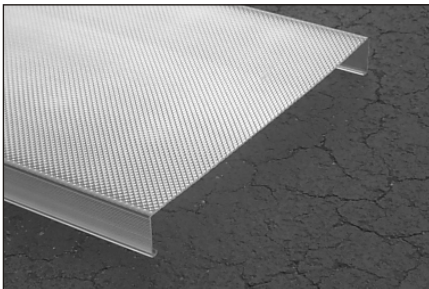

A.L.P. Lighting & Ceiling Products, Inc. is one of the worlds largest manufacturers of lenses, diffusers and louvers for fluorescent fixtures. As such, you can always be assured of quality, proper fit and service. Do business with a company you can trust. A.L.P. replacement plastics, wraparound lenses and diffusers for fluorescent fixtures... easy to order... usually in stock! We can fulfill you needs from one wraparound to hundreds.

- We extrude our own wraparound diffusers in acrylic
- Thousands of molds and wraparounds... one fits your fixture
- Knowledgeable customer service back-up

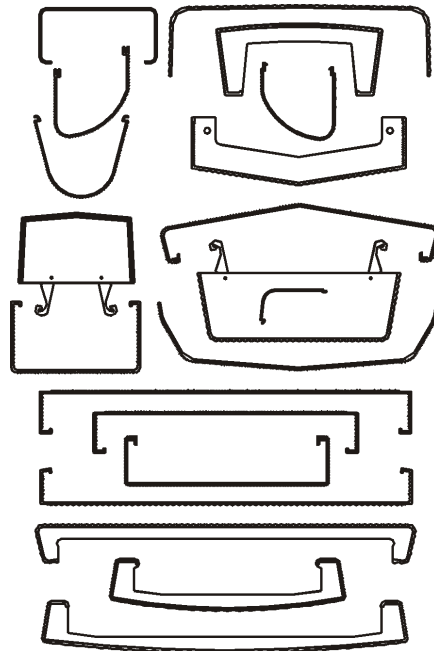

For an accurate drawing, Trace and Fax forms are available. Contact A.L.P. Customer Service.

### THERE ARE TWO EASY WAYS TO ORDER

- 1) Remove old wraparound lens or diffuser from fixture.
- 2) On graph paper provided, place the old wraparound on its end.
- 3) Trace the end shape, being sure to draw both the inside and outside of the lens or diffuser.
- 4) Measure overall length of lens or diffuser - EXACTLY\*.
- 5) Send or give exact measurements and originals to your distributor with purchase order, quantity and type of plastic.

\* If end caps are needed, include accurate drawing. A.L.P. guarantees that all wraparounds are quality acrylic and will not deteriorate or yellow for many years. If the wraparound lens or diffuser that you order is not a stock item, we will make a mold at no additional cost. We can satisfy ANY size order. Quotations upon request! All orders carefully packaged and delivery is guaranteed.